

RTP012BMS WELLER SOLDERING TIP BEVEL CUT (Ø1.2MM) | T0050102099

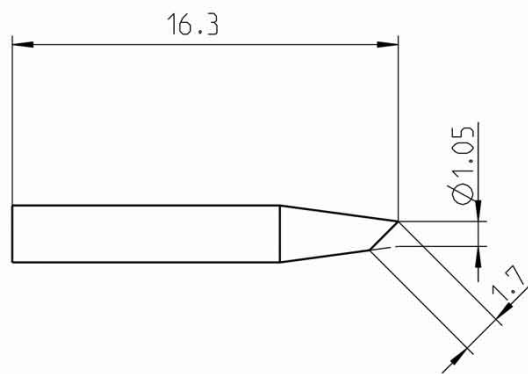

SKU: T0050102099



ORIGINAL WELLER RTP 012 B MS TIP

RTP 012 B MS - Soldering tip with bevel cut Ø 1.2 mm, MIL-SPEC compliant.

RT PICO series high performance active tip, suitable for the smallest components **from XS to S** (0402 to 01005).

Short tip-to-grip distance for maximum precision.

Weller product no.: **T0050102099**.

Specifications

- For WXPP MS soldering iron
- Performance: 40 W
- Heating time (50-350°C): **3 sec.**
- Tip shape: Bevel cut
- Tip diameter: Ø 1.2 mm
- Body diameter: 2.4 mm
- Length: **16.3 mm**
- Compliance: **IPC, MIL-SPEC** (MIL version)



- Radiator technology: Active Tip
- UPC: 037103331489.